

Data Sheet



Article number: 03510190

Description: Fluro Rod end GE 190SW

Measures

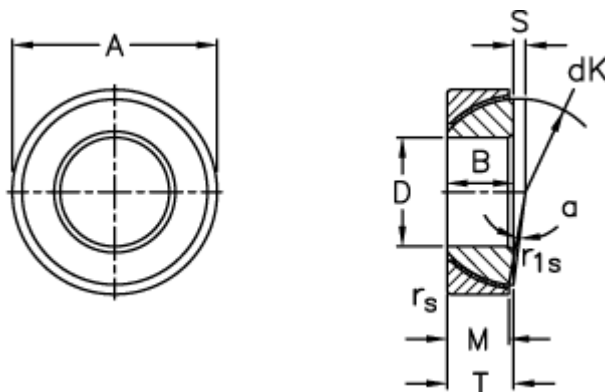

A = 290 0 -0,035

B = 64

D = 190 0 -0,030

dK = 275

Dynamic load C (kN) = 2740

M = 62

rs, r1s min = 3

S = 26

Static load C0 (kN) = 5480

T = 64 +0,35 -0,80

Tilt angle = 0.5

Weight = 18200